

Honeywell

PRELIMINARY

APT4000 Series 4-Wire Toroidal Conductivity Transmitters User Manual

70-82-25-105
EN11-6260
Revision 1 – 11/00



60306

Copyright, Notices, and Trademarks

| | |
|---|--|
| © Copyright 2000 by Honeywell Inc. Revision 1 – 11/00 | |
| While this information is presented in good faith and believed to be accurate, Honeywell disclaims the implied warranties of merchantability and fitness for a particular purpose and makes no express warranties except as may be stated in its written agreement with and for its customer. | |
| In no event is Honeywell liable to anyone for any indirect, special or consequential damages. The information and specifications in this document are subject to change without notice. | |
| Honeywell Industrial Automation and Control Automation College 1100 Virginia Drive Ft. Washington, PA. 19034 | Honeywell S. A. Espace Industriel Nord rue André Durouchez 80084 Amiens Cedex 2 France |

Contacts

The following list identifies important contacts within Honeywell.

| Organization | Telephone | Address |
|---------------------------------------|------------------------------------|---|
| Honeywell Technical Assistance Center | 1-800-423-9883 (USA and Canada) | 1100 Virginia Avenue Fort Washington, PA 19034 |
| Honeywell S.A. | 33-3-22-54-56-56 (Europe) | 80084 Amiens Cedex 2 France |

Safety Precautions

Be sure to read and observe the following requirements!

Before connecting the Transmitter to mains, make sure that the mains voltage lies within the range $24 - 230 \text{ V} \approx \text{ac/dc}, -15 \% / +10 \%$.

Opening the Transmitter exposes live parts, it should not be opened in use. Care must be exercised when connecting signal and power supply cables. If a repair should be required, return the Transmitter to our factory.

If opening the Transmitter is inevitable, it shall first be disconnected from all voltage sources. Make sure that the mains supply has been disconnected.

Repair or adjustment of an opened Transmitter under voltage shall be carried out only by a skilled person who is aware of the hazards involved.

Remember that the voltage across accessible parts of the open Transmitter may be dangerous to life.

Whenever it is likely that the protection has been impaired, the Transmitter shall be made inoperative and secured against unintended operation.

The protection is likely to be impaired if, for example:

- the Transmitter shows visible damage
- the Transmitter fails to perform the intended measurements
- after prolonged storage at temperatures above $70 \text{ }^\circ\text{C}$
- after severe transport stresses

Before recommissioning the Transmitter, a professional routine test in accordance with EN 61010-1 must be performed. This test should be carried out at our factory.

The Transmitter shall not be used in a manner not specified by this manual.

Information on this Instruction Manual

ITALICS are used for texts which appear in the Transmitter display.

Bold print is used to represent keys, e.g. **CAL**.

CAL

Keys for which the functions are explained are frequently shown in the left-hand column.



Notes provide important information that should be strictly followed when using the Transmitter.



Warning means that the instructions given must always be followed for your own safety. Failure to follow these instructions may result in injuries.

Mode Codes

After pressing **CONF** or **CAL** you can enter one of the following codes to access the designated mode:

CONF

CONF, 0000: Error info
CONF, 1200: Configuration mode
CONF, 5555: Current source

CAL

CAL, 0000: Cal info
CAL, 1001: Zero point calibration
CAL, 1015: Temp probe adjustment
CAL, 1100: Cell factor calibration
CAL, 1125: Input/adjustment of sensor factor
CAL, 2222: Test mode

Contents

| | | | |
|---|-----------|--|-----------|
| Safety Precautions | 3 | Keypad | 15 |
| Information on this Instruction Manual | 4 | Safety Functions | 16 |
| Mode Codes | 4 | Outputs | 17 |
| 1 Assembly | 6 | Configuration | 18 |
| Package Contents and Unpacking | 6 | Calibration | 20 |
| Assembly | 6 | Measurement | 24 |
| 2 Installation, Connection and Commissioning | 10 | 4 Diagnostics, Maintenance and Cleaning | 25 |
| Proper Use | 10 | Sensoface®, Sensocheck® | 25 |
| Overview of the Conductivity Transmitter | 10 | Error Messages | 25 |
| Terminal Assignment | 11 | Diagnostics Functions | 27 |
| Installation and Commissioning | 11 | Maintenance and Cleaning | 28 |
| Protective Wiring of Relay Contacts | 12 | 5 Annex | 29 |
| Typical Wirings | 13 | Product Line | 29 |
| 3 Operation | 14 | Specifications | 29 |
| User Interface | 14 | Calibration Solutions | 32 |
| Display | 15 | Concentration Curves | 33 |
| | | Index | 39 |

1 Assembly

Package Contents and Unpacking

Unpack the unit carefully and check the shipment for transport damage and completeness.
The package contains:

- Front unit of Transmitter
- Lower case
- Short instruction sheet
- This instruction manual

- Bag containing:

- | | |
|----------------------|------------------|
| ① 2 sealing plugs | ⑦ 1 hinge pin |
| ② 5 hexagon nuts | ⑧ 3 cable ties |
| ③ 3 cable glands | ⑨ 3 filler plugs |
| ④ 1 rubber reducer | ⑩ 3 gaskets |
| ⑤ 1 sealing plug | ⑪ 1 washer |
| ⑥ 4 enclosure screws | ⑫ 1 jumper |

Assembly

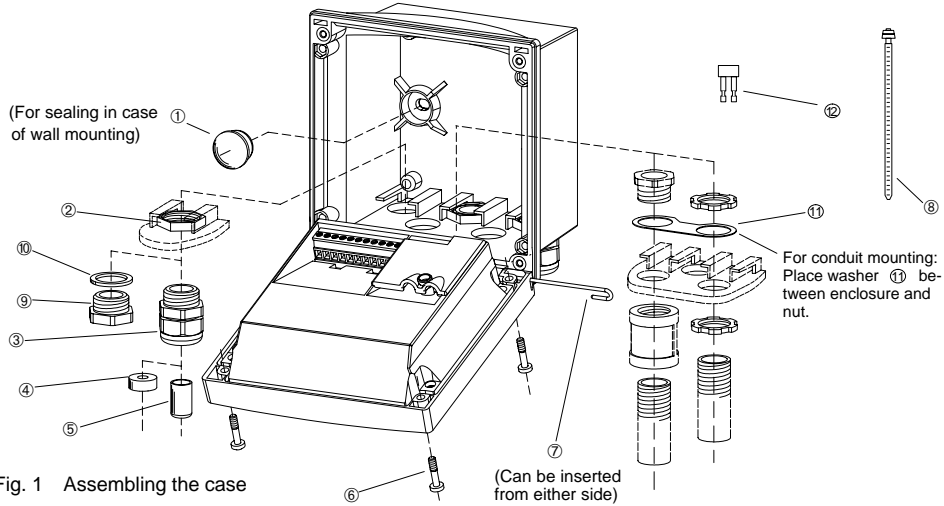

Fig. 1 Assembling the case

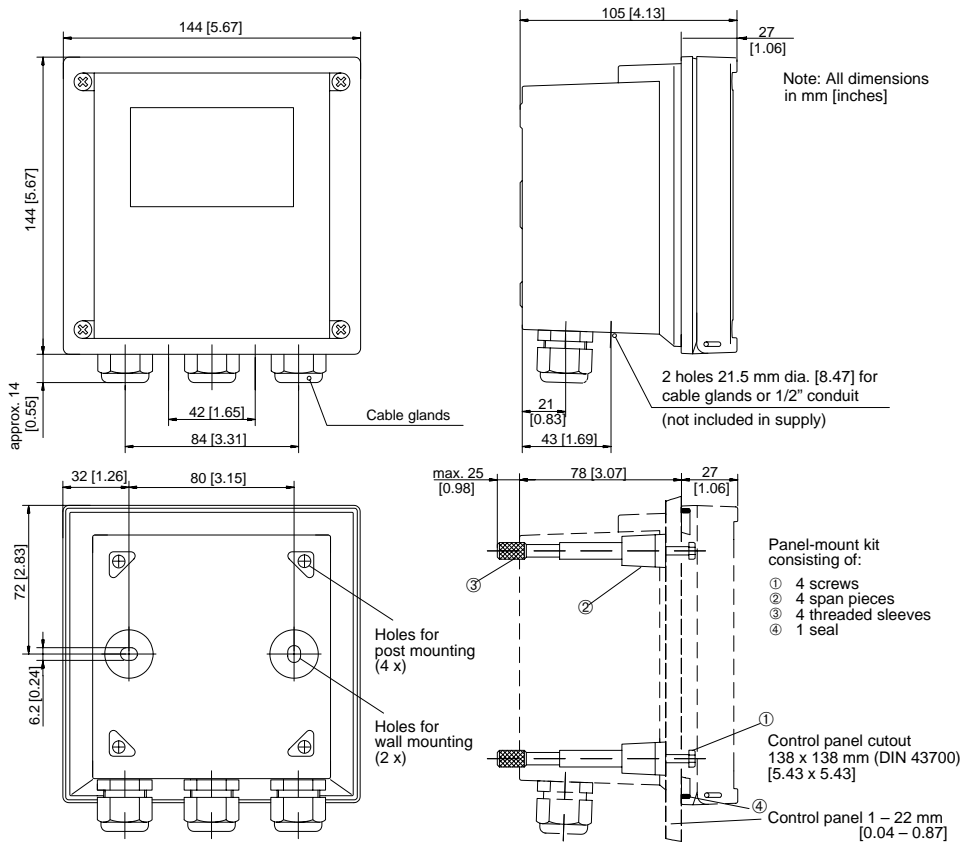

Fig. 2 Dimension drawing for Transmitter, mounting diagram and P/N 51205990-001 panel-mount kit

Pipe-mount kit
consisting of:

- ① 4 self-tapping screws
- ② 1 pipe mounting plate
- ③ 2 hose clamps with worm gear drive to DIN 3017

For vertical or horizontal post/pipe mounting

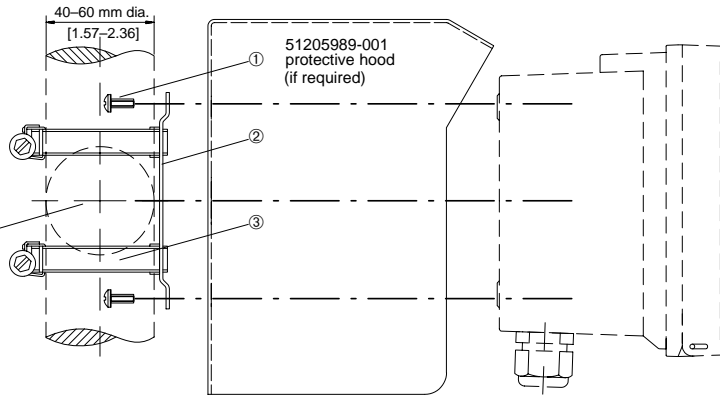

Fig. 3 P/N 51205988-001 pipe-mount kit

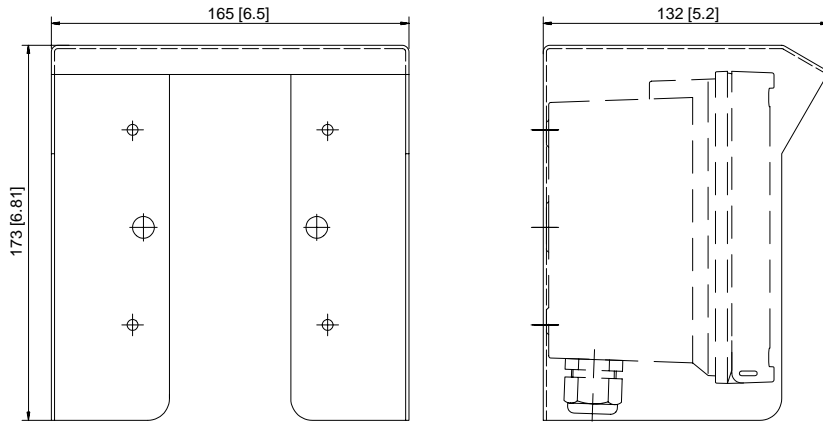

Fig. 4 P/N 51205989-001 protective hood for wall and pipe mounting

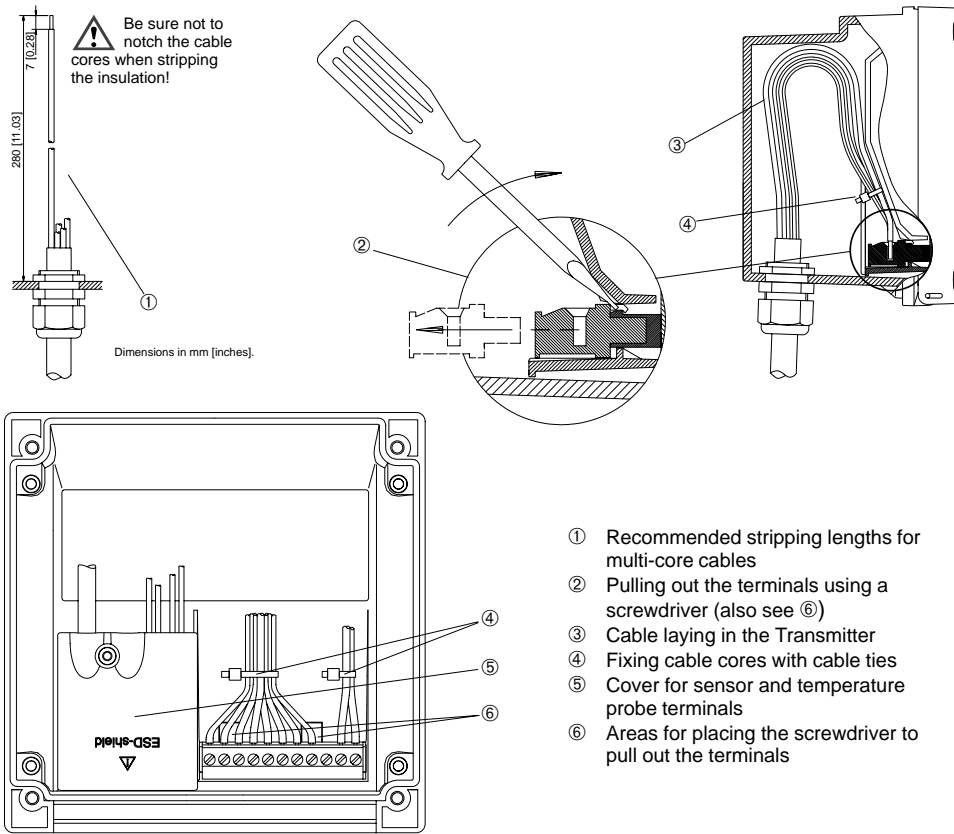

Fig. 5 Installation information APT4000TC Transmitter

2 Installation, Connection and Commissioning

Proper Use

The APT4000TC Transmitter is used for conductivity, concentration and temperature measurement in biotechnology, food processing, pharmaceutical and chemical industry, water and waste-water treatment. It can either be mounted on site or in a control panel.

Overview of the Conductivity Transmitter

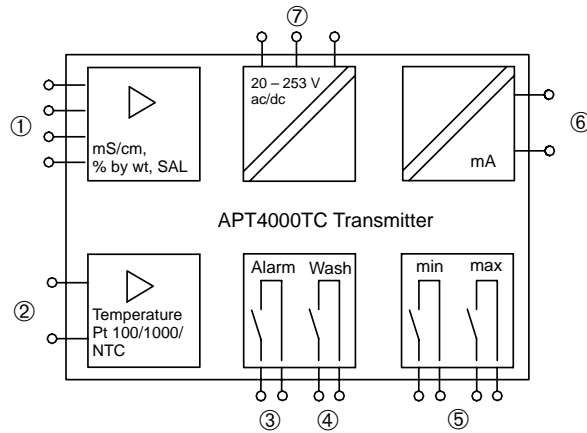

Fig. 6 System functions of Transmitter

- | | |
|--|--|
| ① Input for toroidal conductivity sensor | ⑤ Limit contacts |
| ② Input for temperature probe | ⑥ Current output 0(4) – 20 mA |
| ③ Alarm contact (closed circuit) | ⑦ ac/dc varying-voltage supply unit (24 – 230 V ac/dc –15 % / +10 %, ac: 45 to 65 Hz) |
| ④ Wash contact | |

Terminal Assignment

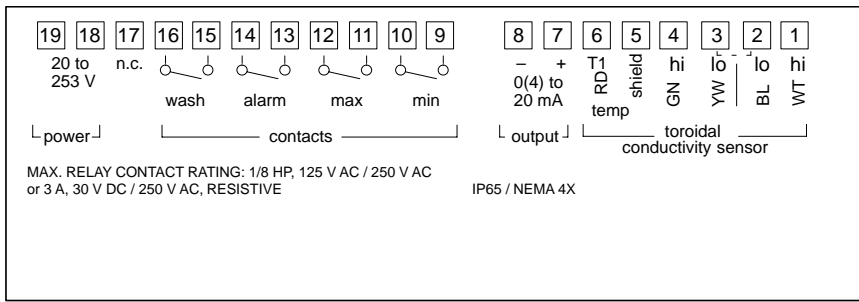





Fig. 7 Terminal assignment of APT4000TC Transmitter

Installation and Commissioning

Warning  *Installation and commissioning of the Transmitter may only be carried out in accordance with this instruction manual and per applicable local and national codes. Be sure to observe the technical specifications and input ratings.*

Warning  The terminals must be fixed with cable ties as shown on page 9.

Warning  Before connecting the Transmitter to the power supply, make sure that its voltage lies within the range 20 – 253 Vac/dc, ac: 45 – 65 Hz.

Warning  When commissioning, a complete configuration must be carried out.

For easier installation, the terminal strips are of a plug-in design. The terminals are suitable for single wires and flexible leads up to 2.5 mm² (AWG 14) (see Pg. 9).
A connection example is shown on Pg. 13.

Protective Wiring of Relay Contacts

Relay contacts are subjected to electrical erosion. Especially with inductive and capacitive loads, the service life of the contacts will be reduced. For suppression of sparks and arcing, components such as RC combinations, nonlinear resistors, series resistors and diodes are used.

Typical protective wirings

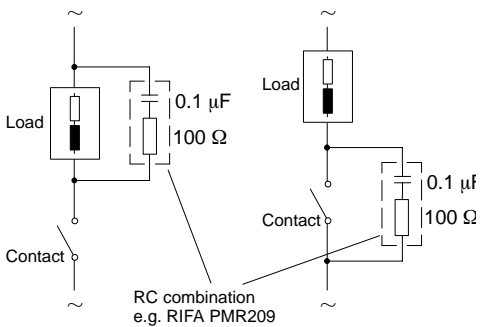

Fig. 8 AC applications with inductive load

Typical RC combination at 230 Vac:
 Capacitor 0.1 μ F / 630 V
 Resistor 100 Ω / 1 W

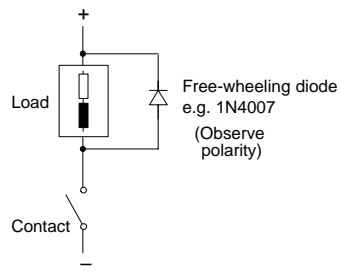

Fig. 9 DC application with inductive load

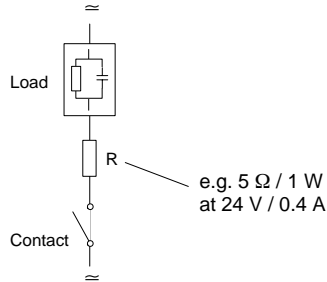
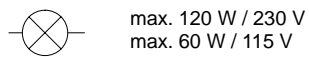

Fig. 10 AC / DC application with capacitive load

Connection of incandescent lamps



Typical Wiring

Conductivity measurement with Honeywell 5000TC toroidal conductivity sensor

The Honeywell 5000TC toroidal conductivity sensor is used to measure low to highest conductivity values. It can be used for measurements in safe areas.

Note 

For special mounting conditions of the sensor, the cell factor can vary between 4.0 and 4.5. Therefore the user should perform a wet calibration of each new sensor to determine the exact cell factor.

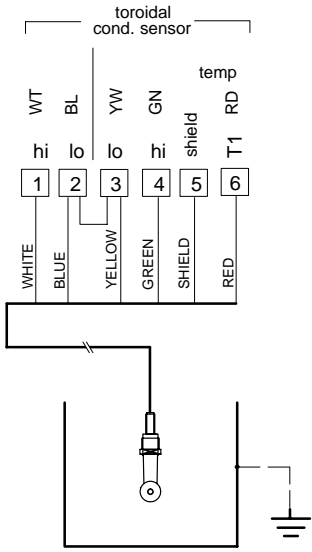

Fig. 11 Conductivity measurement with Honeywell 5000TC toroidal conductivity sensor

Settings for Honeywell 5000TC toroidal conductivity sensor

| | Menu | | Setting |
|--------------------|------|------|---------|
| Temp probe | conf | 1200 | Pt 1000 |
| Cell factor | cal | 1100 | 4.44 |

3 Operation

User Interface

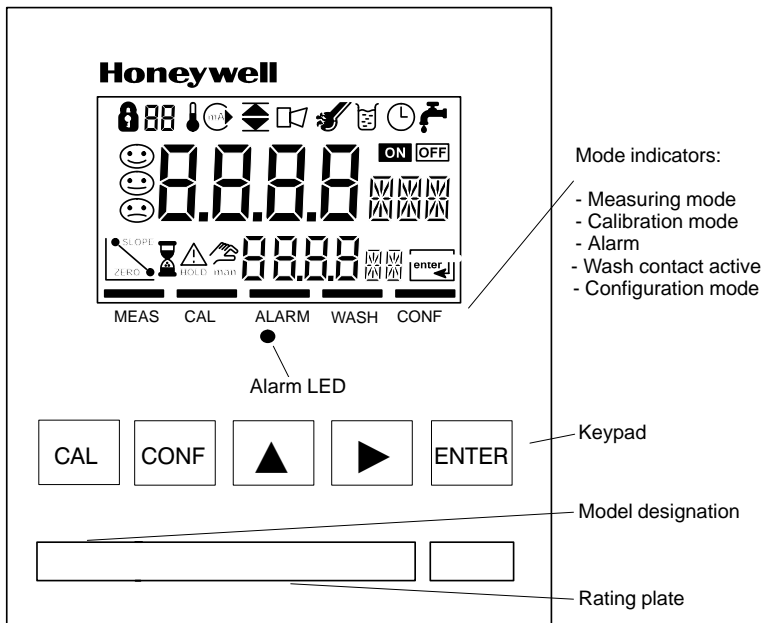

Fig. 12 Front view of Transmitter

Display

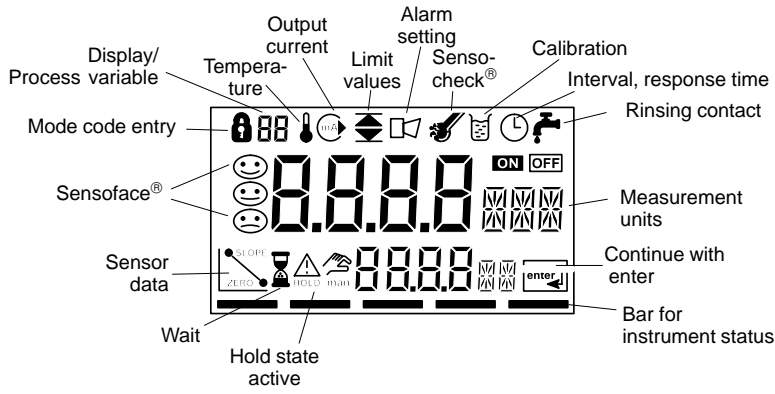

Fig. 13 Transmitter display

Keypad

| | | | |
|--|--|--|--|
| <p>CAL</p> <p>CONF</p> <p>▶</p> <p>▲</p> | <p>Start, end calibration</p> <p>Start, end configuration</p> <p>Select digit position (selected position flashes)</p> <p>Change digit</p> | <p>ENTER</p> <p>cal → enter</p> <p>conf → enter</p> <p>▲ + ▶</p> | <p><u>Prompt in display:</u> continue in program sequence, <u>Configuration:</u> Confirm entries, next configuration step, <u>Measuring mode:</u> Display output current</p> <p>Cal info, display cell factor and zero point (see Pg. 25)</p> <p>Error info, display last output error message (see Pg. 25)</p> <p>Start GainCheck® manual instru- ment self-test (see Pg. 16)</p> |
|--|--|--|--|

Safety Functions

Sensoface[®] sensor monitoring



Sensoface[®] provides information on the sensor condition. A sad “Smiley” indicates that there is a **Sensocheck[®]** message. **Sensocheck[®]** signals a short circuit of the primary coil and its lines as well as an interruption at the secondary coil and its lines. **Sensocheck[®]** can be switched off. With **Sensocheck[®]** switched off, no friendly Smiley appears.

For more detailed information, see chapter “Diagnostic, Maintenance and Cleaning” (Pg. 26).

GainCheck[®] manual instrument self-test

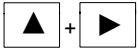

Simultaneously pressing ▲ and ► starts the manual instrument self-test.

A display test is carried out, the software version is displayed and the memory and measured value transmission are checked.

Automatic instrument self-test

The automatic instrument self-test checks the memory and the measured-value transmission. It runs automatically in the background at fixed intervals.

Outputs

Current output

The current output is controlled by the process variable selected in the configuration.



The current characteristic for conductivity can be configured as linear or logarithmic curve.

The current range can be set to either 0 – 20 mA or 4 – 20 mA. The current beginning and end can be set to any desired value.

If LIN (linear characteristic) is chosen, the minimum span is 5% of the selected process variable / measurement range. If LOG (logarithmic characteristic) is chosen, the minimum span is one decade within the chosen range.

To check connected peripherals (e.g. limit switches, controllers), the output current can be manually specified (see Pg. 28).

Limit contacts

The limit contacts report values below the lower limit and above the upper limit or are used, for example, to actuate valves or pumps (also see Pg. 12). One min and one max contact each can be configured as desired within the measurement range. If a value outside the limits is detected,  or  appears in the display.

Alarm contact

The alarm contact is closed during normal operation (closed circuit). It opens in the case of alarm or power outage. As a result, a failure message is provided even in the case of line breakage (also see Pg. 12).

Error messages can also be signaled with a 22 mA signal via the output current (see Configuration, Pg. 19).

Wash contact

With the wash contact the conductivity sensor can be automatically cleaned with a suitable probe. The washing interval and duration can be configured as desired.

Configuration

The instrument arrives from the factory configured and ready to operate as a conductivity transmitter. This section provides detailed procedures for changing operation values for specific applications.



Activate with **CONF** change parameter with ▲ and ►, confirm/continue with **ENTER**, end configuration with **CONF**



Mode code "1200"



HOLD

During configuration the Transmitter is in the Hold state, the output current is frozen, and the limit and alarm contacts are inactive.

When the configuration mode is exited, the Transmitter remains in the Hold state for safety reasons. This prevents undesirable reactions of the connected peripherals (e.g. limit switches, controllers) due to incorrect settings. The measured value and *Hold* are displayed alternately. Now you can check whether the measured value is plausible and specifically end the Hold state with **ENTER**. After 20 sec. (measured value stabilization) the Transmitter returns to measuring mode.

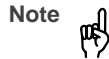













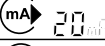
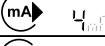
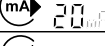
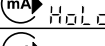

Note The configuration parameters are checked during the input. In the case of an incorrect input "ERR" is displayed for 3 sec. The parameters cannot be stored with **ENTER** until the input has been repeated.

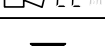
Configuration parameters

Before attempting any changes refer to the parameter setup list shown below. This table presents the possible options and the factory settings.

| Pictograph | Parameter | Choices | Factory setting |
|------------|--|--|-----------------|
| | Process variable / meas. range Selected process variable and measuring range control current output and measured values. Complete configuration required after change. | 00.00 mS / 000.0 mS / 0000 mS 000.0 % 000.0 SAL | 000.0 mS |
| | Concentration (only for %) | -01- NaCl (0 – 28 % by wt) -02- HCl (0 – 17 % by wt) -03- NaOH (0 – 22 % by wt) -04- H ₂ SO ₄ (0 – 35 % by wt) -05- HNO ₃ (0 – 28 % by wt) -06- H ₂ SO ₄ (95 – 99 % by wt) | -01- |

| Pictograph | Parameter | Choices | Factory setting |
|---|---|--|-----------------|
|  | Temperature display | °C °F | °C |
|  | Temperature probe | Pt 100 / Pt 1000 / NTC 100 kΩ | Pt 1000 |
|  | Temperature compensation (not with % and SAL) | OFF LIN NLF (natural waters) | OFF |
|  | Temperature coefficient (only with tc LIN) | xx.xx %/K | 02.00 %/K |
|  | Output current range | 0 – 20 mA / 4 – 20 mA | 4 – 20 mA |
|  | Output current characteristic (not with % and SAL) | LIN LOG | LIN |
|  | Current beginning (0 / 4 mA) (only with LIN) | mS / % / SAL | 000.0 mS |
|  | Current end (20 mA) (only with LIN) | mS / % / SAL | 100.0 mS |
|  | Current beginning (0 / 4 mA) (only with LOG) | mS * | 0.1 mS |
|  | Current end (20 mA) (only with LOG) | mS * | 100.0 mS |
|  | Hold state | Last: Last output current value Fix: Output current specified | Last |
|  | Hold value (only with Fix) | xx.xx mA | 21.00 mA |
|  | 22 mA signal for error message | ON / OFF | OFF |
|  | Limit values min | mS / % / SAL | 000.0 mS |
|  | Limit values max | mS / % / SAL | 100.0 mS |
|  | Sensocheck® | ON / OFF | OFF |

| Picto-graph | Parameter | Choices | Factory setting |
|--|------------------|--------------|-----------------|
|  | Washing interval | xxx.x hours | 000.0 (OFF) |
|  | Washing time | xxxx seconds | 0000 (OFF) |

* 0.1 / 1 / 10 / 100 / 1000 mS

Configuration is cyclical. To stop, press **CONF**.

Calibration

In the calibration mode the cell factor can be modified in two ways. If the cell factor of the sensor in use is known under consideration of the installation conditions, it can be entered directly. Furthermore, the cell factor can be determined with a known calibration solution under consideration of the temperature.



Activate with **CAL**, confirm/continue with **ENTER**, abort with **CAL → ENTER**



During calibration the Transmitter is in the Hold state. The output current is frozen, limit and alarm contacts are inactive.

When the calibration mode is exited, the Transmitter remains in the Hold state for safety reasons. This prevents undesirable reactions of the connected peripherals (e.g. limit switches, controllers) due to incorrect settings. The measured value and *Hold* are displayed alternately. Now you can check whether the measured value is plausible and specifically end the Hold state with **ENTER** or repeat calibration with **CAL**. If you end the Hold state, the Transmitter will return to measuring mode after 20 sec. (measured value stabilization).

Calibration by input of cell factor (CF) (CAL 1100)



Activate calibration by pressing the **CAL** key. Using the ▲, ► keys enter mode code "1100" and then press **ENTER**.



Using the ▲, ► keys enter the cell factor. The lower display shows the conductivity value.

A change in the cell factor also changes the conductivity value.

When there has not been an entry for approx. 6 sec, conductivity and temperature are displayed alternately.



Press **ENTER** to confirm the cell factor.

The Transmitter remains in the Hold state. You can end the Hold state with **ENTER**. After 20 sec (measured value stabilization) the Transmitter returns to measuring mode.

Calibration with calibration solution (CAL 1100)



Press **ENTER** to confirm the cell factor.

Note

Be sure to use known calibration solutions and the respective temperature-corrected table values (see Calibration Solutions, Pg. 33).



The Transmitter remains in the Hold state. You can end the Hold state with **ENTER**. After 20 sec (measured value stabilization) the Transmitter returns to measuring mode.



Activate calibration by pressing the **CAL** key. Using the **▲**, **▶** keys enter mode code "1100" and then press **ENTER**.



Immerse the sensor in the calibration solution.



After approx. 6 sec the lower display alternately shows the conductivity and temperature values. Read the conductivity value corresponding to the displayed temperature from the table of the used calibration solution (for tables see Pg. 33).





Using the **▲**, **▶** keys change the cell factor until the display shows the conductivity value from the table.









Make sure that the temperature is stable during the calibration procedure.

**Zero point calibration in air
(CAL 1001)**

Note  Zero point calibration is only required when very low conductivity values are to be measured.

Note  Before you start calibration, remove the sensor from the process, clean it and dry it up.

 Activate calibration by pressing the **CAL** key. Using the ,  keys enter mode code "1001" and then press **ENTER**.

 Using the ,  keys modify the zero point until the lower display reads 0 μ S. If required, change the sign of the zero point!

 When there has not been an entry for approx. 6 sec, the lower display alternately shows the zero-corrected conductivity value and the temperature value.

 Press **ENTER** to confirm the zero point.



 The Transmitter remains in the Hold state. You can end the Hold state with **ENTER**. After 20 sec (measured value stabilization) the Transmitter returns to measuring mode.



**Input and adjustment of sensor factor
(CAL 1125)**

Note  This function should only be used by experts. Incorrectly set parameters may go unnoticed, but change the measuring properties.

The Transmitter comes with a preset sensor factor of 24.6 for the 5000TC sensor. Should you use another sensor, you must enter another sensor factor or determine it using a comparison resistor. After that, you can calibrate the sensor (see Pg. 21).

Note  Resistance measurement in test mode can only show the correct value of the test resistor when the sensor factor has been correctly determined.

 Activate calibration by pressing the **CAL** key. Using the ,  keys enter mode code "1125" and then press **ENTER**.

 Using the ,  keys enter the sensor factor of the sensor in the main display.

 If you do not know the sensor factor, it can be determined using a comparison resistor (recommended resistance value: 100 Ω). The sensor factor must be adjusted until the corresponding resistance value is shown in the lower display.

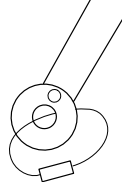



Press **ENTER** to confirm the sensor factor.

Adjustment of temperature probe (CAL 1015)



The Transmitter remains in the Hold state. You can end the Hold state with **ENTER**. After 20 sec (measured value stabilization) the Transmitter returns to measuring mode.

Note

Incorrectly set parameters may go unnoticed, yet change the measurement properties. Temperature probe adjustment is particularly useful when using Pt 100 temperature probes. For NTC temperature probes, an adjustment is not required.



Activate calibration by pressing the **CAL** key.



Using the ▲, ► keys enter mode code "1015" and then press **ENTER**.



Measure the temperature of the process medium using an external thermometer.



Using the ▲, ► keys enter the determined temperature value in the main display. If you take over the temperature value shown in the lower display, the correction is without effect.



Press **ENTER** to confirm the temperature value.



The Transmitter remains in the Hold state. You can end the Hold state with **ENTER**. After 20 sec (measured value stabilization) the Transmitter returns to measuring mode.

Measurement

Measuring mode

In the measuring mode the main display shows the configured process variable and the lower display the temperature.

Cal info

With **CAL** and mode code "0000" you can activate the cal info. Cal info shows the current calibration data for approx. 20 sec. The 20 sec can be reduced by pressing **ENTER**. During cal info the Transmitter is not in Hold state.

Error info

With **CONF** and mode code "0000" you can activate the error info. Error info shows the most recent error message for approx. 20 sec. After that the message will be deleted. The 20 sec can be reduced by pressing **ENTER**. During error info the Transmitter is not in Hold state.

Hold state

The Transmitter will enter the Hold state under the following conditions:



For calibration: Mode code 1001
Mode code 1015
Mode code 1100
Mode code 1125
Mode code 2222

configuration: Mode code 1200
Mode code 5555

The output current is frozen at *Last* or *Fix* (configuration Pg. 19), and the limit and alarm contacts are inactive.

If the calibration or configuration mode is exited, the Transmitter remains in the Hold state for safety reasons. This prevents undesirable reactions of the connected peripherals (e.g. limit switches, controllers) due to incorrect settings. The measured value and *Hold* are displayed alternately. Now you can check whether the measured value is plausible and specifically end the Hold state with **ENTER**. After a relax time of 20 sec. (measured value stabilization) the Transmitter returns to measuring mode.

Note



During error conditions the Hold state will not be active.

4 Diagnostics, Maintenance and Cleaning

Sensoface®, Sensocheck®



Sensoface® provides information on the sensor condition. A sad “Smiley” indicates that there is a Sensocheck® message.

Sensocheck® signals a short circuit of the primary coil and its lines as well as an interruption at the secondary coil and its lines. Sensocheck® can be switched off. With Sensocheck® switched off, no friendly Smiley appears.

Error Messages

When one of the following error messages is output, the unit can no longer correctly determine the process variable or output it via the current output.

During an error message the alarm contact is open and the alarm LED flashes. The alarm response time is permanently set to 10 sec.





Error messages can also be signaled with a 22 mA signal via the current output (see Configuration, Pg. 19).

Error info



With **CONF** and mode code “0000” you can activate the error info. Error info shows the most recent error message for approx. 20 sec. After that the message will be deleted. The 20 sec can be reduced by pressing **ENTER**. During error info the Transmitter is not in Hold state.

| Error number | Display (flashing) | Problem | Possible causes |
|--------------|--------------------|-------------------|---|
| Err 01 | 1179 mA | Sensor | - Wrong cell factor - Outside measurement range - SAL > 45 ‰ - Sensor connection or cable defective |
| Err 02 | | Sensor | - Unsuitable sensor |
| Err 03 | | Temperature probe | - Outside temp range - Outside temp range for TC - Outside temp range for SAL - Outside temp range for concentration |
| Err 21 | | Output current | - Measured value below configured current beginning - Wrong configuration for current beginning (see Pg. 19) |

| Error number | Display (flashing) | Problem | Possible causes |
|--------------|---|-------------------------|---|
| Err 22 |  | Output current | - Measured value above configured current end - Wrong configuration for current end (see Pg. 19) |
| Err 23 |  | Output current | - Configured current span too small (Difference between current beginning and end) |
| Err 33 |  | Sensocheck [®] | - Short circuit in primary coil - Short circuit of cable |
| Err 34 |  | Sensocheck [®] | - Open circuit in secondary coil - Cable interrupted |
| Err 98 | CONF | System error | - Configuration or calibration data defective; completely reconfigure and recalibrate the Transmitter - Measured value transmission defective - Memory error in Transmitter program (PROM defective) |
| Err 99 | FAIL | Factory settings | - EEPROM or RAM defective - Error in factory settings This error message normally should not occur, as the data are protected from loss by multiple safety functions. Should this error message nevertheless occur, there is no remedy. The Transmitter must be repaired and recalibrated at the factory. |

Diagnosics Functions

Cal info

Pressing **CAL** and entering mode code "0000" is going to activate the cal info. Cal info shows the current calibration data for approx. 20 sec. During cal info the Transmitter is not in Hold state.

Test mode

Pressing **CAL** and entering mode code "2222" is going to activate the test mode. In the test mode you can check the measuring equipment with a resistor. Sensoface® is disabled.

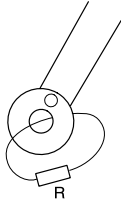

To do so, a comparison resistor is looped through the sensor. The comparison resistance value is indicated in the main display in kΩ. When the resistance value exceeds 2 kΩ, the display shows "----".

R: e.g. 100 Ω

Pressing **ENTER** ends the test mode. The Transmitter goes to Hold state.

Error info

Pressing **CONF** and entering mode code "0000" is going to activate the error info. Error info shows the most recent error message for approx. 20 sec. After that the message will be deleted. During error info the Transmitter is not in Hold state.

Display output current

Pressing **ENTER** in measuring mode displays the output current for a few seconds.

Current source

To check the connected peripherals (e.g. limit switches, controllers), the output current can be manually specified.

Warning



In the current source mode the output current no longer follows the measured value! It is manually specified. Limit and alarm contact are disabled.

Therefore, it must be ensured that the connected devices (control room, controllers, indicators) do not interpret the current value as a measured value!

Pressing **CONF** and entering mode code "5555" is going to activate the current source mode. Specify the output current using **▶**, **▲** and **ENTER**. The present output current is shown in the lower display. Pressing **CONF** exits the current source mode again.

GainCheck® manual instrument self-test

The manual instrument self-test is started by simultaneously pressing **▲** and **▶**.

A display test is carried out, the software version is displayed and the memory and measured-value transmission are checked.

Automatic self-test

The automatic self-test checks the memory and the measured-value transmission. It runs automatically in the background at fixed intervals.

Maintenance and Cleaning

Maintenance

The APT4000TC Transmitter contains no user-repairable components. If problems persist even after reviewing section 4, please contact the factory.

Cleaning

To remove dust, dirt and spots, the external surfaces of the Transmitter may be wiped with a damp, lint-free cloth. A mild household cleaner may also be used if necessary.

5 Annex

Product Line

Units

| | Ref. No. |
|-----------------------------------|-----------------|
| Toroidal Conductivity Transmitter | APT4000TC-0-00 |

Mounting Accessories

| | Ref. No. |
|-----------------|-----------------|
| Pipe-mount kit | 51205988-001 |
| Panel-mount kit | 51205990-001 |
| Protective hood | 51205989-001 |

Specifications

| | | | |
|--------------------------|---|--------------------------------|--|
| Cond input | Input for Series 5000 toroidal conductivity sensor | Sensor standardization* | <ul style="list-style-type: none"> - Entry of cell factor with display of conductivity and temperature - Zero point adjustment - Temperature probe adjustment - Input of sensor factor |
| Process variable/range | 00.00 to 99.99 mS/cm 000.0 to 999.9 mS/cm 0000 to 1999 mS/cm | Permissible cell factors | 0.100 to 19.999 |
| Concentration | 0.0 to 100.0 % by wt. | Permissible sensor factors | 1.00 to 99.99 |
| Salinity | 0.0 to 45.0 ‰ (0 to 35 °C) | Permissible offset | ± 0.5 mS/cm |
| Accuracy** | < 1 % of meas. value ± 0.02 mS/cm | | |
| Sensor monitoring | Sensocheck®: monitoring of primary and lines for short circuit and monitoring of secondary for open circuit (can be switched off) | | |

| | | | |
|--|---|--|---|
| Temp input | Pt 100 / Pt 1000 / NTC 100 k Ω | Min. span | LIN 5 % of selected range LOG 1 decade |
| Ranges | – NTC -20.0 to +130.0 °C -4 to +266 °F – Pt -20.0 to +150.0 °C -4 to +302 °F | Current source | 0.00 mA to 22.00 mA |
| Resolution | 0.1 °C / 1 °F | Relay contacts* | 4 relay contacts, floating Min. limit contact N/O Max. limit contact N/O Alarm contact N/C Wash contact N/O Hysteresis of limit contacts 0.2 % of range**** |
| Accuracy | $\pm 0.5 K^{***}$ | Loadability | ac < 250 V / < 3 A / < 750 VA dc < 30 V / < 3 A / < 90 W (resistive load) |
| Temp compensation* (Ref. temp 25 °C) | LIN 00.00 to 19.99 %/K NLF Natural waters to EN 27888 (0 to 36 °C) | Data retention | > 10 years (EEPROM) |
| Concentration determination | -01- NaCl 0-26.3 % by wt (0 °C) ... 0-28.1 % by wt (100 °C) ... -02- HCl 0-17 % by wt (-20 °C) ... 0-17 % by wt (50 °C) ... -03- NaOH 0-12 % by wt (0 °C) ... 0-22 % by wt (100 °C) ... -04- H ₂ SO ₄ 0-25 % by wt (-17 °C) ... 0-35 % by wt (110 °C) ... -05- HNO ₃ 0-28 % by wt (-20 °C) ... 0-28 % by wt (50 °C) ... -06- H ₂ SO ₄ 95-99 % by wt (-10 °C) ... 95-99 % by wt (110 °C) ... | Protection Against Electrical Shock | to EN 61010-1 |
| Display | LC display, alarm LED | EMC | To EN 50 081-1, EN 50 081-2 EN 50 082-1, EN 50 082-2 EN 61326, EN 61326/A1 |
| Current output* | 0 to 20 mA or 4 to 20 mA, max. 10 V, floating 22 mA for error message* | Power supply | 24 to 230 Vac/dc –15 % / +10 %, ac: 45 to 65 Hz, approx. 2 VA |
| Characteristic* | Linear or logarithmic | Fuse | 160 mA T, 250 V, IEC 127-2/III |
| Output current accuracy | < 0.3 % of current value ± 0.05 mA | Protection class | II |
| Start/End of scale* | As desired within ranges for mS, %, SAL | Overvoltage category | II |
| | | Pollution degree | 2 |

Ambient conditions

Temperature Operating/environmental temp
-20 to +55 °C
Transport and storage temp
-20 to +70 °C

Max. rel. H 80 % up to 31 °C
decreasing linearly to 50 % at 55 °C

Enclosure Material: thermoplastic polyester, reinforced (polybutylene terephthalate)
Protection: IP 65, NEMA 4X
Color: bluish gray RAL 7031

Cable glands 3 breakthroughs for included cable glands
2 breakthroughs for cable glands, NPT 1/2 " or Rigid Metallic Conduit

Dimensions See Dimension drawings, Pg. 7 ff

Weight Approx. 1 kg

* user defined

** ± 1 count

*** with Pt 100 ± 1 K, with NTC > 100 °C < 1 K

**** with % by wt fixed at 0.2%,
with SAL fixed at 0.2 %

Calibration Solutions

| Potassium Chloride Solutions | | | | Sodium Chloride Solutions | | | |
|----------------------------------|---------------|-----------|---------|----------------------------------|---------------|-------------|--------------|
| Electrical Conductivity in mS/cm | | | | Electrical Conductivity in mS/cm | | | |
| Temperature | Concentration | | | Temperature | Concentration | | |
| [°C] | 0.01 mol/l | 0.1 mol/l | 1 mol/l | [°C] | saturated* | 0.1 mol/l** | 0.01 mol/l** |
| 0 | 0.776 | 7.15 | 65.41 | 0 | 134.5 | 5.786 | 0.631 |
| 5 | 0.896 | 8.22 | 74.14 | 1 | 138.6 | 5.965 | 0.651 |
| 10 | 1.020 | 9.33 | 83.19 | 2 | 142.7 | 6.145 | 0.671 |
| 15 | 1.147 | 10.48 | 92.52 | 3 | 146.9 | 6.327 | 0.692 |
| 16 | 1.173 | 10.72 | 94.41 | 4 | 151.2 | 6.510 | 0.712 |
| 17 | 1.199 | 10.95 | 96.31 | 5 | 155.5 | 6.695 | 0.733 |
| 18 | 1.225 | 11.19 | 98.22 | 6 | 159.9 | 6.881 | 0.754 |
| 19 | 1.251 | 11.43 | 100.14 | 7 | 164.3 | 7.068 | 0.775 |
| 20 | 1.278 | 11.67 | 102.07 | 8 | 168.8 | 7.257 | 0.796 |
| 21 | 1.305 | 11.91 | 104.00 | 9 | 173.4 | 7.447 | 0.818 |
| 22 | 1.332 | 12.15 | 105.94 | 10 | 177.9 | 7.638 | 0.839 |
| 23 | 1.359 | 12.39 | 107.89 | 11 | 182.6 | 7.831 | 0.861 |
| 24 | 1.386 | 12.64 | 109.84 | 12 | 187.2 | 8.025 | 0.883 |
| 25 | 1.413 | 12.88 | 111.80 | 13 | 191.9 | 8.221 | 0.905 |
| 26 | 1.441 | 13.13 | 113.77 | 14 | 196.7 | 8.418 | 0.927 |
| 27 | 1.468 | 13.37 | 115.74 | 15 | 201.5 | 8.617 | 0.950 |
| 28 | 1.496 | 13.62 | | 16 | 206.3 | 8.816 | 0.972 |
| 29 | 1.524 | 13.87 | | 17 | 211.2 | 9.018 | 0.995 |
| 30 | 1.552 | 14.12 | | 18 | 216.1 | 9.221 | 1.018 |
| 31 | 1.581 | 14.37 | | 19 | 221.0 | 9.425 | 1.041 |
| 32 | 1.609 | 14.62 | | 20 | 226.0 | 9.631 | 1.064 |
| 33 | 1.638 | 14.88 | | 21 | 231.0 | 9.838 | 1.087 |
| 34 | 1.667 | 15.13 | | 22 | 236.1 | 10.047 | 1.111 |
| 35 | 1.696 | 15.39 | | 23 | 241.1 | 10.258 | 1.135 |
| 36 | | 15.64 | | 24 | 246.2 | 10.469 | 1.159 |
| | | | | 25 | 251.3 | 10.683 | 1.183 |
| | | | | 26 | 256.5 | 10.898 | 1.207 |
| | | | | 27 | 261.6 | 11.114 | 1.232 |
| | | | | 28 | 266.9 | 11.332 | 1.256 |
| | | | | 29 | 272.1 | 11.552 | 1.281 |
| | | | | 30 | 277.4 | 11.773 | 1.306 |
| | | | | 31 | 282.7 | 11.995 | 1.331 |
| | | | | 32 | 288.0 | 12.220 | 1.357 |
| | | | | 33 | 293.3 | 12.445 | 1.382 |
| | | | | 34 | 298.7 | 12.673 | 1.408 |
| | | | | 35 | 304.1 | 12.902 | 1.434 |
| | | | | 36 | 309.5 | 13.132 | 1.460 |

Data source: K. H. Hellwege (Editor), H. Landolt, R. Börnstein: Zahlenwerte und Funktionen Volume 2, Part. Volume 6

Data source: * K. H. Hellwege (Editor), H. Landolt, R. Börnstein: Zahlenwerte und Funktionen Volume 2, Part. Volume 6

** Test solutions calculated according to IEC 746-3

Concentration Curves

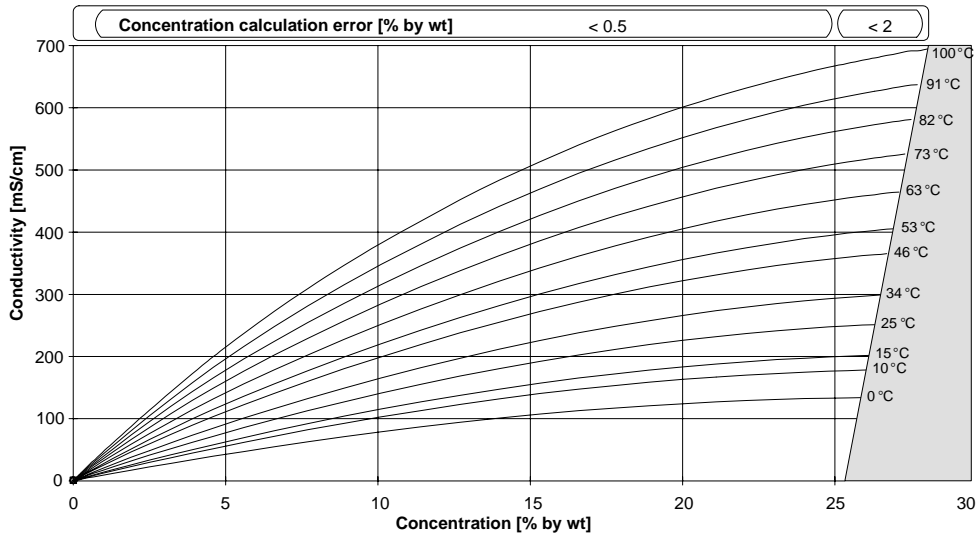

Fig. 14 Concentration curves NaCl (configuration: concentration -01-)

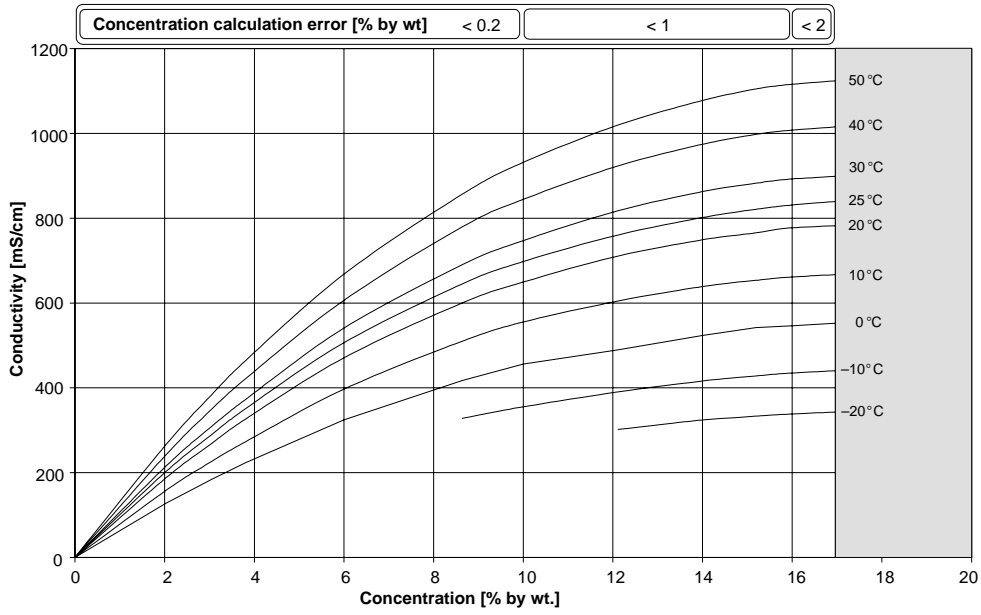

Fig. 15 Concentration curves HCl (configuration: concentration -02-)

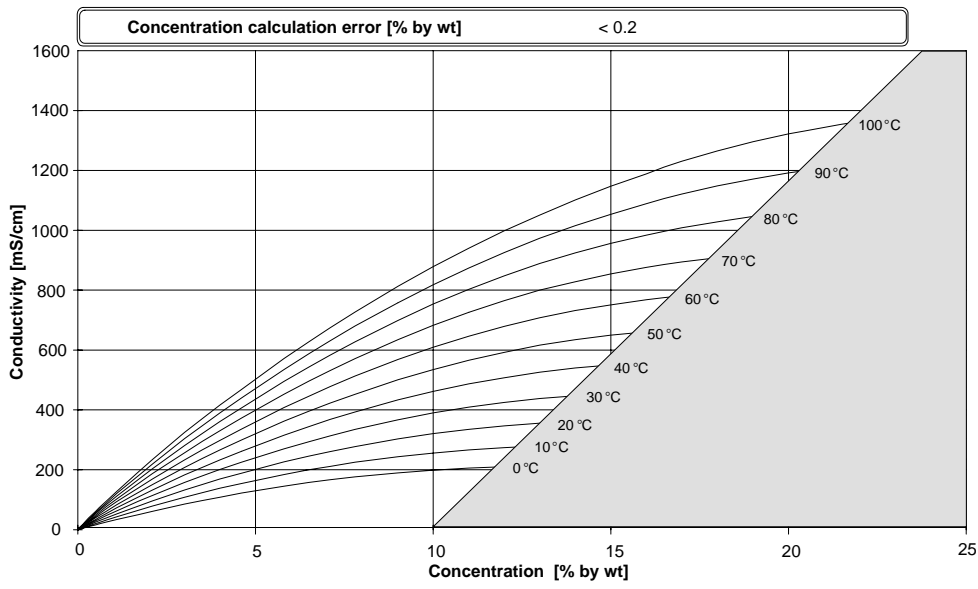

Fig. 16 Concentration curves NaOH (configuration: concentration -03-)

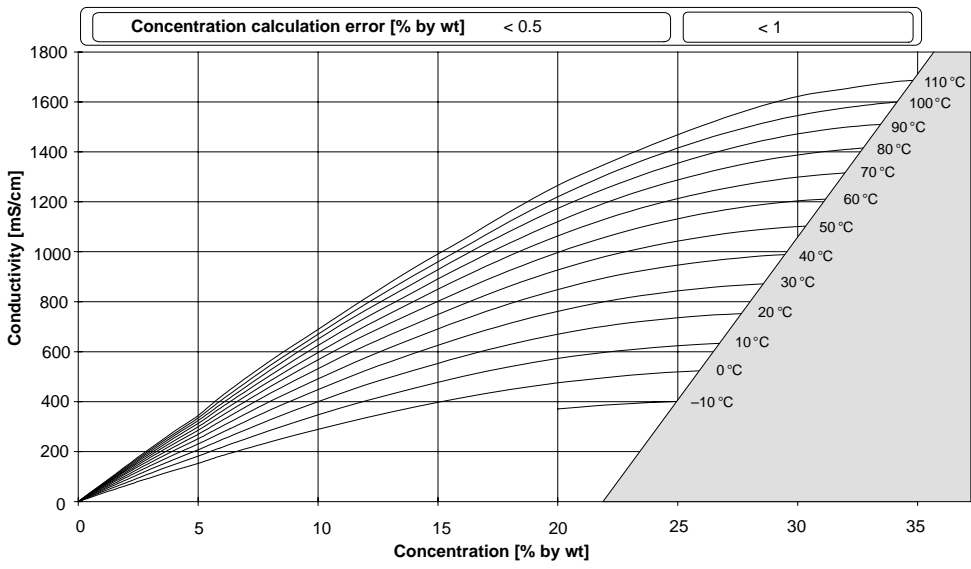

Fig. 17 Concentration curves H₂SO₄ (configuration: concentration -04-)

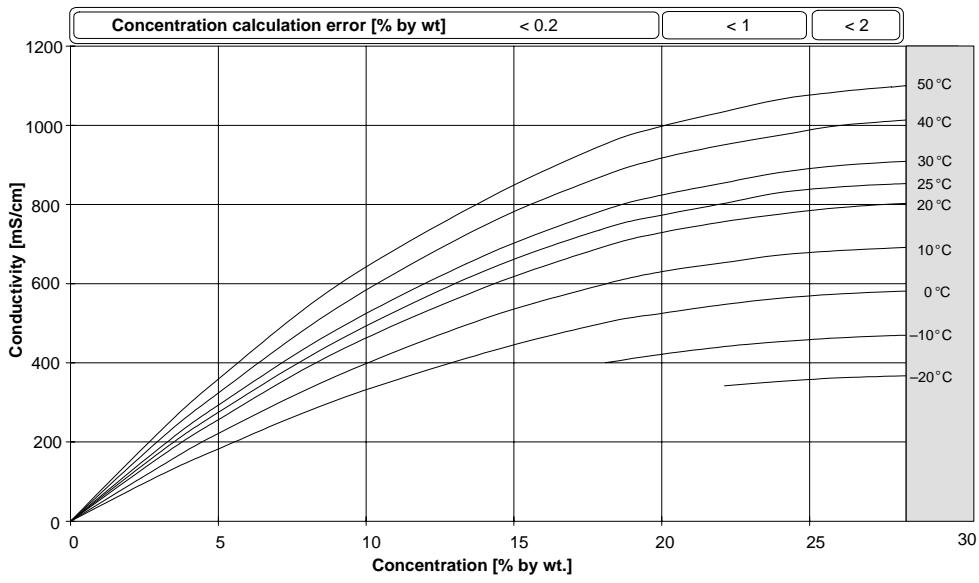

Fig. 18 Concentration curves HNO₃ (configuration: concentration -05-)

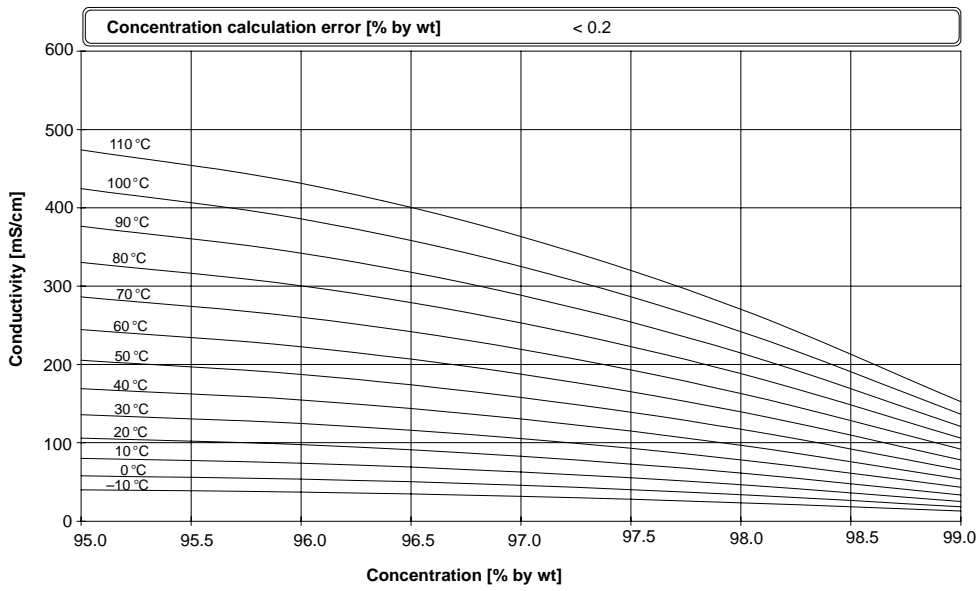

Fig. 19 Concentration curves H₂SO₄ (range 95 to 99 % by wt), (configuration: concentration -06-)

Index

😊 😞, 26

22 mA signal for alarm, 17, 26
configuring, 19

A

Alarm, response time, 26

Alarm contact, 17, 26

Alarm LED, 26

Alarm via current output, 17, 26
configuring, 19

Assembly, 6

C

Cal info, 25, 28

Calibration, 21
input of cell factor, 21
sensor factor adjustment, 23
temp probe adjustment, 24
with calibration solution, 22
zero point, in air, 23

Calibration data, display, 28

Calibration solutions, 33

Cell factor, input of, 21

Cleaning, 29

Concentration curves, 34

Conductivity measurement, 25

Configuration, 18

Connecting, lines, 9

Connecting cable, fixing, 9

Contacts
inactive, 25
protective wiring, 12

Current characteristic, configur-
ing, 19

Current output, 17
frozen, 25

Current source, 28

D

Diagnostics functions, 28

Dimension drawings, 7

Display, 15

E

Error info, 25, 26, 28

Error message, last, 25, 26, 28

Error message via current output,
17, 26
configuring, 19

Error messages, 26–29

G

GainCheck, 16, 28

H

Hold state, 25

I

Installation, 11

Instrument self-test
automatic, 16, 29
manual, 16, 28

K

Keypad, 15

L

Limit contacts, 17

Limit value max, configuring, 19

Limit value min, configuring, 19

M

Maintenance, 29

Measurement, 25

Measuring mode, 25

Messages, Sensoface, 26

Mode code, 4

Mounting diagram, 7

-
- O**
- Output current
 - configuring, 19
 - display, instantaneous, 28
 - Hold state, 19
 - Hold value, 19
 - Outputs, 17
- P**
- Packing list, 6
 - Pipe-mount kit, 8
 - Process variable, configuring, 18
 - Product line, 30
 - Protective hood, 8
- R**
- Relay contacts, protective wiring, 12
- S**
- Safety precautions, 3
 - Salinity, configuring, 18
 - Self-test
 - automatic, 16, 29
 - manual, 16, 28
 - Sensocheck, 26
 - on or off, 19
 - Sensoface, 16
 - diagnostics, 26
 - messages, 26
 - Sensor factor, adjustment, 23
 - Sensor monitoring, Sensoface, 26
 - Sensors, monitoring, 16
 - Smiley, 26
 - Software version, display, 16, 28
 - Specifications, 30
 - Stripping lengths, 9
- T**
- Temp probe adjustment, 24
 - Terminals, pulling out, 9
 - Test mode, 28
- U**
- User Interface, 14
- W**
- Wash contact, 17
 - Washing interval, configuring, 20
 - Washing time, configuring, 20
 - Wiring example, 13
-

Honeywell

Sensing and Control
Honeywell Inc.
11 West Spring Street
Freeport, IL 61032
USA

Honeywell S. A.
Espace Industriel Nord
Rue André Durouchez
80084 Amiens Cedex 2
France